

INFORMATION IN THIS DRAWING IS SUBJECT TO CHANGE WITHOUT NOTICE. NO PART OF THIS DRAWING MAY BE REPRODUCED OR TRANSMITTED IN ANY FORM OR BY ANY MEANS, ELECTRONIC OR MECHANICAL, FOR ANY PURPOSE WITHOUT THE WRITTEN PERMISSION OF AQUA GLASS CORPORATION.

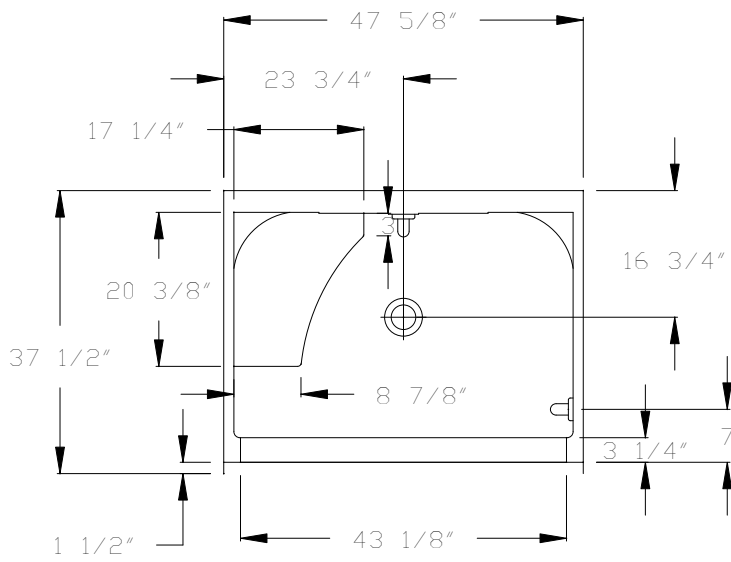

TOP VIEW

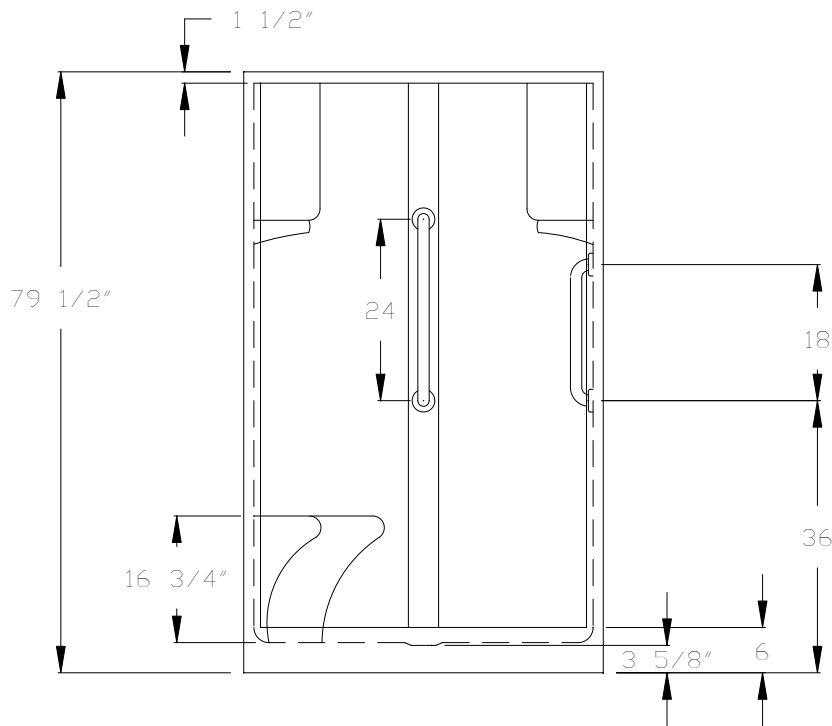

FRONT VIEW

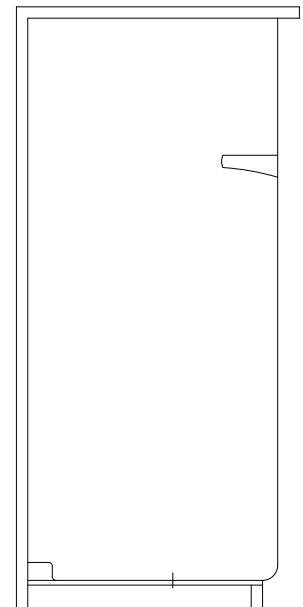

SIDE VIEW

TOLERANCE:
±1/4
REV.:
SCO. NO.:
749
SCO. DATE:
11/30/03

AQUA GLASS ©

320 INDUSTRIAL PARK RD.
ADAMSVILLE, TN 38310

PRODUCT NO.:
614837G-R/L

PRODUCT NAME:
DOMELESS
ACRYLIC
OPTION 3

GENERAL NOTES:

SHOWER DOOR OPENING:
43 1/8" X 72"